

# LEDH-310ICAR

120 and 277 VAC to Low Voltage, 3.5" LED IC Rated Recessed Housing for New Construction and Retrofits

Catalog #		Type
Project		Date
Prepared by		

## MR16 LED Bulb

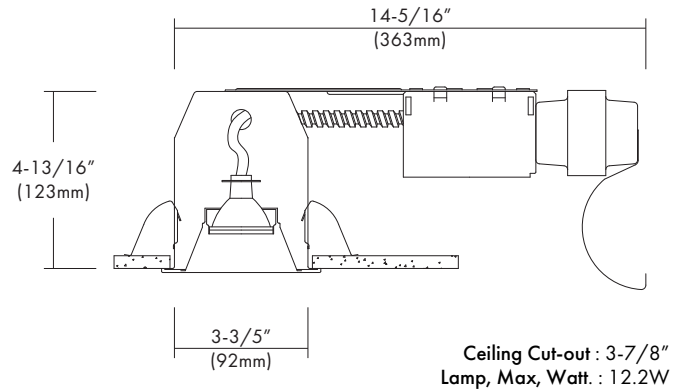

## DESCRIPTION

The LEDH-310ICAR is designed for insulated ceilings and can be in direct contact with insulation material. The LEDH-310ICAR offers a wide choice of trim types including reflector, lensed and wall wash trims. This AIR-TIGHT housing design prevents airflow through the ceiling, helping save on heating and cooling costs.

## DESIGN FEATURES

### Housing

- Galvanized steel housing painted white
- 5-1/2" height allows use in 2"X6" joist construction.
- Housing adjusts for ceilings up to 1-1/2" thick.

### Junction Box

- Listed for through branch circuit wiring.  
(Max.8 No 12 AWG 90°C branch circuit conductors.(4 in, 4 out)
- (5) 1/2" knockouts with true pry-out slots and (4) knockouts with Romex cable clamp.
- Ground wire provided on J-box.

### Transformer

- 120V magnetic transformer steps line voltage down to 12V operating voltage for lamps up to 15W Max.
- Available 277V-12V transformer.

### Socket

- GU5.3 Ceramic Bi-Pin Socket.

### Lamp

- LED MR16 12V 12.2W Max.  
(Not Included: see "Cree COB LED at end of section for Specs and ordering information)

### Remold Clips

- 4 remodel clips secure housing and accommodates 1/2" and 5/8" ceiling materials.

### Optional "Quick Connect" Push-in Wire Connectors.

- Three "Quick Connectors"
- Pre-installed push-in wire connectors for fast and easy wiring.

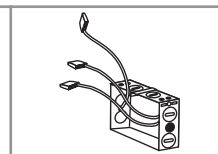

### Listing

- cETLus Damp Location.

Recommended Dimmer
Lutron : D i v a (Dv-600P) Skylark ( S -600P) Ariadni (AY-600P)
<b>Consult tech. service or factory for additional dimmers</b>

# Designs/Trims

For LEDH-310ICA, LEDH-310ICAR

## MR16 LED Bulb

**LT-350**

**Shower Frosted Flat Lens**

Die-Cast Construction  
O.D : 4-5/16"



LT-350WH

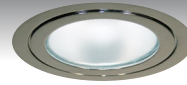

LT-350CH



LT-350SN

**LT-351**

**Shower Convex Shape Lens**

Die-Cast Construction  
O.D : 4-5/16"



LT-351WH

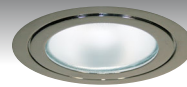

LT-351CH



LT-351MO

**LT-352**

**Tapered Glass Diffuser**

Die-Cast Construction  
O.D : 4-5/16"



LT-352WH



LT-352WH-B



LT-352BK

**LT-354**

**Adjustable Reflector**

Die-Cast Construction  
O.D : 4-5/16"



LT-354CL



LT-354CL-CH



LT-354WH

**LT-355**

**Adjustable Baffle**

Die-Cast Construction  
O.D : 4-5/16"

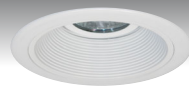

LT-355WH

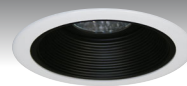

LT-355BK

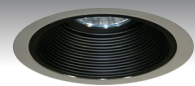

LT-355BK-CH

**LT-358**

**Pin Spot w/ Baffle**

Die-Cast Construction  
O.D : 4-5/16"



LT-358BK



LT-358BK-SN

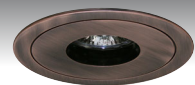

LT-358BK-MO

**LT-359**

**Pin Spot w/ Reflector**

Die-Cast Construction  
O.D : 4-5/16"



LT-359CL



LT-359BK-SN

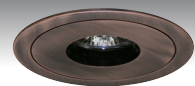

LT-359BK-MO

**LT-360**

**Slotted Wall Wash**

Die-Cast Construction  
O.D : 4-5/16"



LT-360WH



LT-360SN



LT-360MO

# Designs/Trims

For LEDH-310ICA, LEDH-310ICAR

## MR16 LED Bulb

**LT-361**

**Adjustable Wall Wash w/Baffle**

Die-Cast Construction  
O.D : 4-5/16"



LT-361WH

LT-361PB

LT-361MO

**LT-362**

**Dropped Clear Etched Lens**

Die-Cast Construction  
O.D : 4-5/16"



LT-362WH

LT-362BK

LT-362SN

**LT-364**

**Gimbal w/Baffle**

Die-Cast Construction  
O.D : 4-5/16"



LT-364WH

LT-364BK-SN

LT-364BK-MO

## Ordering Information

Model	Voltage	-Options	Design / Trim*																																				
LEDH-310ICAR = 3.5", IC Remodel	Blank = 120V to 12V 277 = 277V to 12V	-E = Electronic Transformer -Q = Quick Wire Connectors	<table border="0"> <tr> <td>LT-350WH = White</td> <td>LT-355WH = White</td> <td>LT-361WH = White</td> </tr> <tr> <td>LT-350CH = Chrome</td> <td>LT-355BK = Black</td> <td>LT-361PB = Polished Brass</td> </tr> <tr> <td>LT-350SN = Satin Nickel</td> <td>LT-355BK-CH = Black-Chrome</td> <td>LT-361MO = Mocha</td> </tr> <tr> <td>LT-351WH = White</td> <td>LT-358BK = Black</td> <td>LT-362WH = White</td> </tr> <tr> <td>LT-351CH = Chrome</td> <td>LT-358BK-SN = Black-Satin Nickel</td> <td>LT-362BK = Black</td> </tr> <tr> <td>LT-351MO = Mocha</td> <td>LT-358BK-MO = Black-Mocha</td> <td>LT-362SN = Satin Nickel</td> </tr> <tr> <td>LT-352WH = White</td> <td>LT-359CL = Clear</td> <td>LT-364WH = White</td> </tr> <tr> <td>LT-352WH-B = White-Blue</td> <td>LT-359BK-SN = Black-Satin Nickel</td> <td>LT-364BK-SN = Black-Satin Nickel</td> </tr> <tr> <td>LT-352BK = Black</td> <td>LT-359BK-MO = Black-Mocha</td> <td>LT-364BK-MO = Black-Mocha</td> </tr> <tr> <td>LT-354CL = Clear</td> <td>LT-360WH = White</td> <td></td> </tr> <tr> <td>LT-354CL-CH = Clear-Chrome</td> <td>LT-360SN = Satin Nickel</td> <td></td> </tr> <tr> <td>LT-354WH = White</td> <td>LT-360MO = Mocha</td> <td></td> </tr> </table>	LT-350WH = White	LT-355WH = White	LT-361WH = White	LT-350CH = Chrome	LT-355BK = Black	LT-361PB = Polished Brass	LT-350SN = Satin Nickel	LT-355BK-CH = Black-Chrome	LT-361MO = Mocha	LT-351WH = White	LT-358BK = Black	LT-362WH = White	LT-351CH = Chrome	LT-358BK-SN = Black-Satin Nickel	LT-362BK = Black	LT-351MO = Mocha	LT-358BK-MO = Black-Mocha	LT-362SN = Satin Nickel	LT-352WH = White	LT-359CL = Clear	LT-364WH = White	LT-352WH-B = White-Blue	LT-359BK-SN = Black-Satin Nickel	LT-364BK-SN = Black-Satin Nickel	LT-352BK = Black	LT-359BK-MO = Black-Mocha	LT-364BK-MO = Black-Mocha	LT-354CL = Clear	LT-360WH = White		LT-354CL-CH = Clear-Chrome	LT-360SN = Satin Nickel		LT-354WH = White	LT-360MO = Mocha	
LT-350WH = White	LT-355WH = White	LT-361WH = White																																					
LT-350CH = Chrome	LT-355BK = Black	LT-361PB = Polished Brass																																					
LT-350SN = Satin Nickel	LT-355BK-CH = Black-Chrome	LT-361MO = Mocha																																					
LT-351WH = White	LT-358BK = Black	LT-362WH = White																																					
LT-351CH = Chrome	LT-358BK-SN = Black-Satin Nickel	LT-362BK = Black																																					
LT-351MO = Mocha	LT-358BK-MO = Black-Mocha	LT-362SN = Satin Nickel																																					
LT-352WH = White	LT-359CL = Clear	LT-364WH = White																																					
LT-352WH-B = White-Blue	LT-359BK-SN = Black-Satin Nickel	LT-364BK-SN = Black-Satin Nickel																																					
LT-352BK = Black	LT-359BK-MO = Black-Mocha	LT-364BK-MO = Black-Mocha																																					
LT-354CL = Clear	LT-360WH = White																																						
LT-354CL-CH = Clear-Chrome	LT-360SN = Satin Nickel																																						
LT-354WH = White	LT-360MO = Mocha																																						

Example : LEDH-310ICAR277-Q

LT-350WH

\* Consult factory for other Color Temperatures and Finishes